

Technical Accessory Guides (TAGs)

For Associates, Resellers, ISVs and Alliance Partners

Global



Version: Active-Only

Will only show products that are known to be available for sale

Need to provide an update or change?
Contact <mailto:pgw786@zebra.com>



For Internal Use by
PartnerConnect Members Only



LI/DS 36xx Technical Accessory Guide



NOTE: This document is only for general reference. Solutions Pathway and related PMBs should be used for product availability, pricing, and final solution selection.

* Zebra does not endorse or specifically recommend any **third-party products, accessories, or hardware**. ZEBRA DISCLAIMS ANY AND ALL LIABILITY, INCLUDING ANY EXPRESS OR IMPLIED WARRANTIES, WHETHER ORAL OR WRITTEN, FOR SUCH THIRD PARTY PRODUCTS, ACCESSORIES, OR HARDWARE. THE CUSTOMER ACKNOWLEDGES THAT NO REPRESENTATION HAS BEEN MADE BY ZEBRA AS TO THE FITNESS OF THE THIRD-PARTY PRODUCTS, ACCESSORIES, OR HARDWARE FOR THE CUSTOMER'S INTENDED PURPOSE.

Cradles

Part Number		Description	Notes	Required Items
STB3678-C100F3WW STB3678-C100F3CN (for use in mainland China only)		LI/DS3678 Charging-Communication Cradle	<ul style="list-style-type: none"> ▶ Provides radio and charging capabilities ▶ Up to 7 scanners can be paired per cradle. 	<ul style="list-style-type: none"> ▶ Host communication cable and possibly a power supply depending on the host cable type. ▶ Forklift Cradle Mounting Bracket (BRKT-MM0036W-00) when mounting on a forklift.
FLB3678-C100F3WW FLB3678-C100F3CN (for use in mainland China only)		LI/DS3678 Sealed Charging-Communication Cradle	<ul style="list-style-type: none"> ▶ Provides radio and charging capabilities ▶ IP65 sealed for installations requiring wash-down (i.e. forklift installations) ▶ Has stiffer retention spring than Standard Cradle (STB3678-C100F3WW) for holding scanner better in fork lift installations. ▶ Up to 7 scanners can be paired per cradle. 	<ul style="list-style-type: none"> ▶ Host communication cable and possibly a power supply depending on the host cable type. ▶ Forklift Cradle Mounting Bracket (BRKT-MM0036W-00) when mounting on a forklift.
BT-RS5X6-DNGL-01		Bluetooth Adapter	<ul style="list-style-type: none"> ▶ Allows 3678 series to be easily connected with hosts that do not have a Bluetooth radio for direct communication. ▶ Pairing barcode on adapter is scanned to instantly pair with the 3678 scanner. ▶ Up to 7 scanners can be paired per adapter. ▶ Paging button on adapter will trigger all paired scanners to beep, ideal for locating misplaced/hidden scanners. ▶ Adapter is powered from host via USB. ▶ Adapter can be easily mounted vertically or horizontally on tabletops, walls, poles, etc. using zip ties or screws (not included). 	<ul style="list-style-type: none"> ▶ USB Scanner Cable (CBA-U46-S07ZAR)

KT-RS5X6-BTDCBL-01		Bluetooth Adapter KIT	<ul style="list-style-type: none"> ▶ Allows 3678 series to be easily connected with hosts that do not have a Bluetooth radio for direct communication. ▶ Pairing barcode on adapter is scanned to instantly pair with the 3678. ▶ Up to 7 scanners can be paired per adapter. ▶ Paging button on adapter will trigger all paired scanners to beep, ideal for locating misplaced/hidden scanners. ▶ Adapter is powered from host via USB. ▶ Adapter can be easily mounted vertically or horizontally on tabletops, walls, poles, etc. using zip ties or screws (not included). ▶ Kit includes: <ul style="list-style-type: none"> - Bluetooth Adapter (BT-RS5X6-DNGL-01) - USB Scanner Cable (CBA-U46-S07ZAR) 	
SAC3600-4001CR		4-Slot Battery Charger	<ul style="list-style-type: none"> ▶ Charges up to 4 spare batteries ▶ A fully depleted battery will charge in about 4.5 hours. ▶ Can be wall mounted using two screws and keyed holes on back of charger. 	<ul style="list-style-type: none"> ▶ Power Supply (PWR-BGA12V50W0WWW and CBL-DC-375A1-01) ▶ AC Line Cord (23844-00-00R or country specific version)
SAC3600-KIT		4-Slot Battery Charger Kit	<ul style="list-style-type: none"> ▶ Charges up to 4 spare batteries ▶ A fully depleted battery will charge in about 4.5 hours. ▶ Can be wall mounted using two screws and keyed holes on back of charger. ▶ Includes 4-Slot Battery Charger (SAC3600-4001CR), Power Supply (PWR-BGA12V50W0WWW), DC Line Cord (CBL-DC-375A1-01), and AC Line Cord (23844-00-00R) 	



Communication Cables







NOTE: 36xx series uses different cables than 34xx/35xx series. Do not interchange cables.

Standard USB Cables

NOTE: DS3608-ER requires that host can provide 1.0A peak (800 mA average) current on USB port. A cable with an external power supply jack and an external power supply will be required if this is not possible.



Alternative is to switch "Extended Range Power Mode" option to 500 mA (requires firmware version CAACJS00-004-R03 - Nov 2017 or higher). This option may reduce extended range read distance when used in low lighting conditions.

Part Number	Picture	Description	Notes	Required Items
CBA-U46-S07ZAR		Shielded USB Cable: Series A Connector, 7ft. Straight	<ul style="list-style-type: none"> ▶ Cable rated for 1.2A current ▶ When connected to STB3678/FLB3678, will charge a fully depleted battery in about 4.5 hours if host USB port is BC 1.2 compatible or about 10.5 hours for USB 2.0 host ports. 	
CBA-U47-S15ZAR		Shielded USB Cable: Series A Connector, 15ft. Straight	<ul style="list-style-type: none"> ▶ Cable rated for 1.2A current ▶ When connected to STB3678/FLB3678, will charge a fully depleted battery in about 4.5 hours if host USB port is BC 1.2 compatible or about 10.5 hours for USB 2.0 host ports. 	

CBA-UF1-S07ZAR		Shielded USB Cable: Series A Connector, 7ft. Straight (Freezer Rated)	<ul style="list-style-type: none"> ▶ Cable rated for 1.2A current ▶ Rated to -30°C for freezer environment use. ▶ When connected to STB3678/FLB3678, will charge a fully depleted battery in about 4.5 hours if host USB port is BC 1.2 compatible or about 10.5 hours for USB 2.0 host ports. 	
CBA-U42-S07PAR		Shielded USB Cable: Series A Connector, 7ft. Straight - Powered	<ul style="list-style-type: none"> ▶ Can be used with host devices not capable of providing 1.2A current on USB port. ▶ When connected to STB3678/FLB3678 without a power supply, will charge a fully depleted battery in about 4.5 hours if host USB port is BC 1.2 compatible or about 10.5 hours for USB 2.0 host ports. 	<ul style="list-style-type: none"> ▶ External power supply if host is not capable of providing proper current for scanner. ▶ Filter Adapter Cable (CBL-36-453A-01) required if using DC Line Cord (CBL-DC-375A1-01) or legacy PWRS-14000-148R power supply on STB/FLB cradles
CBA-U44-S15PAR		Shielded USB Cable: Series A Connector, 15ft. Straight - Powered	<ul style="list-style-type: none"> ▶ Can be used with host devices not capable of providing 1.2A current on USB port. ▶ When connected to STB3678/FLB3678 without a power supply, will charge a fully depleted battery in about 4.5 hours if host USB port is BC 1.2 compatible or about 10.5 hours for USB 2.0 host ports. 	<ul style="list-style-type: none"> ▶ External power supply if host is not capable of providing proper current for scanner.
CBA-UF6-C09ZAR		Shielded USB Cable: Series A Connector, 9ft. Coiled (Freezer Rated)	<ul style="list-style-type: none"> ▶ Cable rated for 1.2A current ▶ Coiled cable is 9 ft long when extended and is about 5 ft. long when un-extended. ▶ Rated to -30°C for freezer environment use. ▶ Cable can be used with standard USB connectors on vehicle mount computers (i.e. VH10, VC80, including Gamber-Johnson ET5X forklift cradle) ▶ When connected to STB3678/FLB3678, will charge a fully depleted battery in about 4.5 hours if host USB port is BC 1.2 compatible or about 10.5 hours for USB 2.0 host ports. 	
CBA-UF6-C12ZAR		Shielded USB Cable: Series A Connector, 9ft. Coiled (Freezer Rated)	<ul style="list-style-type: none"> ▶ Cable rated for 1.2A current ▶ Coiled cable is 9 ft long when extended (even though SKU indicates 12 ft.) and is about 5 ft. long when un-extended. Use CBA-UF8-C12ZAR for a true 12 ft. length cable. ▶ Rated to -30°C for freezer environment use. ▶ Cable can be used with standard USB connectors on vehicle mount computers (i.e. VH10, VC80, including Gamber-Johnson ET5X forklift cradle) ▶ When connected to STB3678/FLB3678, will charge a fully depleted battery in about 4.5 hours if host USB port is BC 1.2 compatible or about 10.5 hours for USB 2.0 host ports. 	
CBA-UF6-C09ZAR-KIT ▶ Discontinued 12/2023 - see PMB 11157				
CBA-UF8-C12ZAR		Shielded USB Cable: Series A Connector, 12ft. Coiled (Freezer Rated)	<ul style="list-style-type: none"> ▶ Cable rated for 1.2A current ▶ Coiled cable is 12 ft long when extended and is about 5 ft. long when un-extended. ▶ Rated to -30°C for freezer environment use. ▶ Cable can be used with standard USB connectors on vehicle mount computers (i.e. VH10, VC80, including Gamber-Johnson ET5X forklift cradle) ▶ When connected to STB3678/FLB3678, will charge a fully depleted battery in about 4.5 hours if host USB port is BC 1.2 compatible or about 10.5 hours for USB 2.0 host ports. 	

CBA-U61-S07ZAR		Shielded USB Cable: USB-C Connector, 7ft. Straight	<ul style="list-style-type: none"> ▶ Connects 3600 series scanners to host devices with USB-C ports (i.e. laptops, tablets, etc.) ▶ Cable rated for 1.2A current ▶ When connected to STB3678/FLB3678, will charge a fully depleted battery in about 4.5 hours if host USB port is BC 1.2 compatible or about 10.5 hours for USB 2.0 host ports. ▶ NOTE: Zebra Android units do not support scanners in SSI mode connected to USB-C port. Scanner must be used in USB HID mode. 	
----------------	---	--	--	--

IBM POS USB Cables

Part Number	Picture	Description	Notes	Required Items
CBA-U43-S07ZAR		USB Cable: Power Plus Connector, 7ft. Straight	▶ Can support 5V or 12V power, scanner dependent.	
CBA-U45-S15ZAR		USB Cable: Power Plus Connector, 15ft. Straight	▶ Can support 5V or 12V power, scanner dependent.	

RS232 Cables





NOTE: DS3608-ER requires that host can provide 1.0A peak (800 mA average) current on the powered serial port. A cable with an external power supply jack and an external power supply will be required if this is not possible.



Alternative is to switch "Extended Range Power Mode" option to 500 mA (requires firmware version CAACJS00-004-R03 - Nov 2017 or higher). This option may reduce extended range read distance when used in low lighting conditions.

Part Number	Picture	Description	Notes	Required Items
CBA-R07-S07PAR		RS232 Cable:STD-DB9 Female, TxD on 2, 7ft. Straight		Requires external power supply
CBA-RF0-S07PAR		RS232 Cable:STD-DB9 Female, TxD on 2, 7ft. Straight (Freezer Rated)	▶ Rated to -30°C for freezer environment use.	Requires external power supply
CBA-R21-S15PAR		RS232 Cable:STD-DB9 Female, TxD on 2, 15ft. Straight		Requires external power supply

CBA-RF1-C09PAR		RS232 Cable:STD-DB9 Female, TxD on 2, 9ft. Coiled (Freezer Rated)	<ul style="list-style-type: none"> ▶ Rated to -30°C for freezer environment use. ▶ Coiled cable is 9 ft long when extended and is about 5 ft. long when un-extended. 	Requires external power supply
CBA-R71-C09ZAR		RS232 Cable:STD-DB9 Female, 9ft. Coiled, TxD on 2, PWR Pin 9	<ul style="list-style-type: none"> ▶ This cable is recommended for use with the VC80, VH10, 8585/8595, and 8515. ▶ When connected to STB3678/FLB3678, will charge a fully depleted battery in about 5 hours if host provides 1A current or about 10.5 hours if host provides 500 mA current. ▶ Coiled cable is 9 ft long when extended and is about 5 ft. long when un-extended. 	
CBA-RF2-C09ZAR		RS232 Cable:STD-DB9 Female, TxD on 2, 9ft. Coiled, PWR Pin 9 (Freezer Rated)	<ul style="list-style-type: none"> ▶ This cable is recommended for use with the VC80, VH10, 8585/8595, and 8515. ▶ Can be used to connect 3608 scanners to Network Connect for Manufacturing Adapters. ▶ Rated to -30°C for freezer environment use. ▶ When connected to STB3678/FLB3678, will charge a fully depleted battery in about 5 hours if host provides 1A current or about 10.5 hours if host provides 500 mA current. ▶ Coiled cable is 9 ft long when extended and is about 5 ft. long when un-extended. 	
CBA-RF3-C09ZAR		RS232 Cable: True Cvt, STD-DB9 Female, TxD on 2, 9ft. Coiled, PWR Pin 9 (Freezer Rated)	<ul style="list-style-type: none"> ▶ This cable is recommended for use with the VC70. ▶ Cable provides ±5V signaling (RS232C) needed by some older PLC's which may not support TTL signalling ▶ Rated to -30°C for freezer environment use. ▶ When connected to STB3678/FLB3678, will charge a fully depleted battery in about 5 hours if host provides 1A current or about 10.5 hours if host provides 500 mA current. ▶ Coiled cable is 9 ft long when extended and is about 5 ft. long when un-extended. 	
CBA-RF5-S07ZAR		RS232 Cable:STD-DB9 Female, PWR Pin 9, TxD on 2, 7ft. Straight (Freezer Rated)	<ul style="list-style-type: none"> ▶ Can be used to connect STB3678/FLB3678 to Network Connect for Manufacturing Adapters. ▶ Rated to -30°C for freezer environment use. ▶ When connected to STB3678/FLB3678, will charge a fully depleted battery in about 5 hours if host provides 1A current or about 10.5 hours if host provides 500 mA current. 	
CBL-36-S15EX-01		RS232 Extension Cable - DB9 male to female, 15 ft. Straight Extension, PWR Pin 9 (Freezer Rated)	<ul style="list-style-type: none"> ▶ Cable is typically used with Network Connect for Manufacturing Adapters to extend the cable length of the CBA-RF5-S07ZAR cable. ▶ Rated to -30°C for freezer environment use. 	▶ RS232 Cable:STD-DB9 Female, PWR Pin 9, TxD on 2 7ft. Straight (CBA-RF5-S07ZAR)
Keyboard Wedge Cables				
Part Number	Picture	Description	Notes	Required Items

CBA-K63-S07PAR		Keyboard Wedge Cable: PS/2, Power Port, 7ft. Straight - Powered		Requires external power supply
IBM 468x/469x POS Cables				
Part Number	Picture	Description	Notes	Required Items
CBA-M65-S07ZAR		IBM 468x/9x, Port 9B Cable, 7ft. Straight	► Supports host auto-detect so configuration barcode is not needed to put device into IBM Host mode.	
Scanner Emulation Cables - Not supported on 36xx series				
Wand Cables - Not supported on 36xx series				
Synapse Adapter Cables - Not supported on 36xx series				
Vehicle Mount Computer Cables				
Part Number	Picture	Description	Notes	Required Items
CBA-R71-C09ZAR		RS232 Cable:STD-DB9 Female, 9ft. Coiled, TxD on 2, PWR Pin 9	► This cable is recommended for use with the VC80, VH10, 8585/8595, and 8515. ► When connected to STB3678/FLB3678, will charge a fully depleted battery in about 5 hours if host provides 1A current or about 10.5 hours if host provides 500 mA current. ► Coiled cable is 9 ft long when extended and is about 5 ft. long when un-extended.	
CBA-RF2-C09ZAR		RS232 Cable:STD-DB9 Female, TxD on 2, 9ft. Coiled, PWR Pin 9 (Freezer Rated)	► This cable is recommended for use with the VC80, VH10, 8585/8595, and 8515. ► Rated to -30°C for freezer environment use. ► When connected to STB3678/FLB3678, will charge a fully depleted battery in about 5 hours if host provides 1A current or about 10.5 hours if host provides 500 mA current. ► Coiled cable is 9 ft long when extended and is about 5 ft. long when un-extended.	
CBA-U66-C09ZAR (non freezer rated) CBA-UF6-C09ZAR (rated to -30°C for freezer environment use)		Shielded USB Cable: Series A Connector, 9ft. Coiled	► Cable rated for 1.2A current ► Coiled cable is 9 ft long when extended and is about 5 ft. long when un-extended. ► Cable can be used with standard USB connectors on vehicle mount computers. ► When connected to STB3678/FLB3678, will charge a fully depleted battery in about 4.5 hours if host USB port is BC 1.2 compatible or about 10.5 hours for USB 2.0 host ports.	

CBA-UF6-C12ZAR		Shielded USB Cable: Series A Connector, 9ft. Coiled (Freezer Rated)	<ul style="list-style-type: none"> ▶ Cable rated for 1.2A current ▶ Coiled cable is 9 ft long when extended (even though SKU indicates 12 ft.) and is about 5 ft. long when un-extended. Use CBA-UF8-C12ZAR for a true 12 ft. length cable. ▶ Rated to -30°C for freezer environment use. ▶ Cable can be used with standard USB connectors on vehicle mount computers (i.e. VH10, VC80, including Gamber-Johnson ET5X forklift cradle) ▶ When connected to STB3678/FLB3678, will charge a fully depleted battery in about 4.5 hours if host USB port is BC 1.2 compatible or about 10.5 hours for USB 2.0 host ports. 	
CBA-UF6-C09ZAR-KIT ▶ Discontinued 12/2023 see PMB 11157				
CBA-UF8-C12ZAR		Shielded USB Cable: Series A Connector, 12ft. Coiled (Freezer Rated)	<ul style="list-style-type: none"> ▶ Cable rated for 1.2A current ▶ Coiled cable is 12 ft long when extended and is about 5 ft. long when un-extended. ▶ Rated to -30°C for freezer environment use. ▶ Cable can be used with standard USB connectors on vehicle mount computers (i.e. VH10, VC80, including Gamber-Johnson ET5X forklift cradle) ▶ When connected to STB3678/FLB3678, will charge a fully depleted battery in about 4.5 hours if host USB port is BC 1.2 compatible or about 10.5 hours for USB 2.0 host ports. 	
CBA-RF3-C09ZAR		RS232 Cable: True Cvtr, STD DB9 Female, TxD on 2, 9ft. Coiled, PWR Pin 9 (Freezer Rated)	<ul style="list-style-type: none"> ▶ This cable is recommended for use with the VC70. ▶ Cable provides ±5V signaling (RS232C) needed by some older PLC's which may not support TTL signalling ▶ Rated to -30°C for freezer environment use. ▶ When connected to STB3678/FLB3678, will charge a fully depleted battery in about 5 hours if host provides 1A current or about 10.5 hours if host provides 500 mA current. ▶ Coiled cable is 9 ft long when extended and is about 5 ft. long when un-extended. 	
CBA-UF2-C12ZAR		VC70N0 to 36xx Cable (USB)	<ul style="list-style-type: none"> ▶ USB cable locks onto VC70 using two screws ▶ Coiled cable is 9 ft long when extended (even though SKU indicates 12 ft.) and is about 5 ft. long when un-extended. Use CBA-UF7-C12ZAR for a true 12 ft. length cable. ▶ Rated to -30°C for freezer environment use. ▶ When connected to STB3678/FLB3678, will charge a fully depleted battery in about 10 hours (provides 500 mA current to cradle). 	
CBA-RF4-C09ZBR		VC5000 or FLC9000 to 36xx Cable (serial)	<ul style="list-style-type: none"> ▶ Coiled cable is 9 ft long when extended and is about 5 ft. long when un-extended. ▶ Rated to -30°C for freezer environment use. ▶ Not capable of powering DS3608-ER, unless Extended Range Power Mode is changed to 500 mA. ▶ When connected to STB3678/FLB3678, will charge a fully depleted battery in about 10.5 hours. ▶ Includes increased TTL current limit protection vs. CBA-RF-C09ZAR. 	

CBA-UF3-C09ZAR		VC5000 or FLC9000 to 36xx Cable (USB)	<ul style="list-style-type: none"> ▶ This cable can't be used on full screen VC5090 units that use an external keyboard since the keyboard uses the same rugged USB connector. ▶ Coiled cable is 9 ft long when extended and is about 5 ft. long when un-extended. ▶ Rated to -30°C for freezer environment use. ▶ Not capable of powering DS3608-ER, unless Extended Range Power Mode is changed to 500 mA. Use CBA-UF5-C09ZAR instead. ▶ When connected to STB3678/FLB3678, will charge a fully depleted battery in about 10.5 hours. 	
CBA-UF5-C09ZAR		VC5000 or FLC9000 to DS3608-ER "Y" Cable (USB)	<ul style="list-style-type: none"> ▶ Y cable design connects to: <ul style="list-style-type: none"> - VC5090: COM1 or COM2 AND USB A port - FLC9000: COM1 AND USB port (requires 25-71915-01R USB host adapter) ▶ USB communication between VC5090/ FLC9000 and scanner. NOTE: MC92 may need to be set to USB Host Mode. ▶ COM1 or COM2 port provides additional power needed for DS3608-ER in default power mode. NOTE: An application (i.e. SerialWedge or DataWedge) must be used to open the COM port before power will be applied to it. ▶ Coiled cable is 9 ft long when extended and is about 5 ft. long when un-extended. ▶ Rated to -30°C for freezer environment use. 	

Network Connect for Manufacturing Adapters

Part Number	Picture	Description	Notes	Required Items
EA3600-T1CP-00 (Point-To-Point)		36XX Series Network Connect for Manufacturing Adapter - TCP/IP	<ul style="list-style-type: none"> ▶ Adapter connects 36xx series scanners to hosts via TCP/IP connection. ▶ Connects to 36xx scanner via serial connection and will power scanner (including DS3608-ER in default power mode). ▶ Adapter is IP40 rated, -30°C to +50°C operating temp. 	<ul style="list-style-type: none"> ▶ Serial Scanner Cable for DS36xx <ul style="list-style-type: none"> - For STB/FLB 3678 Cradle (cordless scanners) use CBA-RF5-S07ZAR - For 3608 (corded scanners) use CBA-RF2-C09ZAR If required, 15 ft. extension cable (CBL-36-S15EX-01) can be used with either cable listed above. ▶ External Power (if Adapter will not be powered from 24V connection) <ul style="list-style-type: none"> - Power Supply (PWR-BGA12V50W0WWW) - DC Line Cord (CBL-DC-388A1-01) - AC Line Cord (23844-00-00R or country specific version) ▶ Power Over Ethernet (PoE) <ul style="list-style-type: none"> - See Power Supply section below for a 3rd party PoE solution.

<p>EA3600-R0PF50S-00 (Point-To-Point)</p>		<p>3678 Series Network Connect for Manufacturing Adapter Point-To-Point Kit - <u>Rockwell (EtherNet/IP)</u>, Modbus, TCP/IP</p>	<ul style="list-style-type: none"> ▶ Adapter kit connects 3678 cordless series scanner to Programmable Logic Controllers (PLC) used in manufacturing environments. ▶ Uses industrial protocol used by the following PLC vendors: <ul style="list-style-type: none"> - EtherNet/IP (Rockwell) - Modbus TCP ▶ Also supports generic TCP/IP connections to non-PLC hosts. ▶ Adapter is IP40 rated, -30°C to +50°C operating temp. ▶ Point-To-Point model supports connection of one 3678 scanner and provides support for host notification of scanner trigger information. ▶ Kit includes Point-To-Point EA3600 (FRU-3600-R1CP), Cradle (STB3678-C100F3WW), and Serial Cable (CBA-RF5S07ZAR) 	<ul style="list-style-type: none"> ▶ One 3678 series scanner ▶ External Power (if Adapter will not be powered from 24V connection) <ul style="list-style-type: none"> - Power Supply (PWR-BGA12V50W0WW) - DC Line Cord (CBL-DC-388A1-01) - AC Line Cord (23844-00-00R or country specific version) ▶ Power Over Ethernet (PoE) <ul style="list-style-type: none"> - See Power Supply section below for a 3rd party PoE solution. <p>If required, 15 ft. extension cable (CBL-36-S15EX-01) can be used.</p>
<p>EA3600-R0MF50S-00 (Multi-Point)</p>		<p>3678 Series Network Connect for Manufacturing Adapter Multi-Point Kit - <u>Rockwell (EtherNet/IP)</u>, Modbus, TCP/IP</p>	<ul style="list-style-type: none"> ▶ Adapter kit connects 3678 cordless series scanners to Programmable Logic Controllers (PLC) used in manufacturing environments. ▶ Uses industrial protocol used by the following PLC vendors: <ul style="list-style-type: none"> - EtherNet/IP (Rockwell) - Modbus TCP ▶ Also supports generic TCP/IP connections to non-PLC hosts. ▶ Adapter is IP40 rated, -30°C to +50°C operating temp. ▶ Multi-Point configuration provides support for up to 7 scanners - does not provide host notification of scanner(s)' trigger info. ▶ Kit includes Multi-Point EA3600 (EA3600-R1CM00), Cradle (STB3678-C100F3WW), and Serial Cable (CBA-RF5S07ZAR) 	<ul style="list-style-type: none"> ▶ One to seven 3678 series scanners ▶ External Power (if Adapter will not be powered from 24V connection) <ul style="list-style-type: none"> - Power Supply (PWR-BGA12V50W0WW) - DC Line Cord (CBL-DC-388A1-01) - AC Line Cord (23844-00-00R or country specific version) ▶ Power Over Ethernet (PoE) <ul style="list-style-type: none"> - See Power Supply section below for a 3rd party PoE solution. <p>If required, 15 ft. extension cable (CBL-36-S15EX-01) can be used.</p>

<p>EA3600-S0MF50S-00 (Multi-Point)</p>		<p>3678 Series Network Connect for Manufacturing Adapter Multi-Point Kit - <u>Siemens (Profinet)</u>, Modbus, TCP/IP</p>	<ul style="list-style-type: none"> ▶ Adapter kit connects 3678 cordless series scanners to Programmable Logic Controllers (PLC) used in manufacturing environments. ▶ Uses industrial protocol used by the following PLC vendors: <ul style="list-style-type: none"> - Profinet (Siemens) - Modbus TCP ▶ Also supports generic TCP/IP connections to non-PLC hosts. ▶ Adapter is IP40 rated, -30°C to +50°C operating temp. ▶ Multi-Point configuration provides support for up to 7 scanners - does not provide host notification of scanner(s)' trigger info. ▶ Kit includes Multi-Point EA3600 (EA3600-S1CM-00), Cradle (STB3678-C100F3WW), and Serial Cable (CBA-RF5S07ZAR) 	<ul style="list-style-type: none"> ▶ One to seven 3678 series scanners ▶ External Power (if Adapter will not be powered from 24V connection) <ul style="list-style-type: none"> - Power Supply (PWR-BGA12V50W0WW) - DC Line Cord (CBL-DC-388A1-01) - AC Line Cord (23844-00-00R or country specific version) ▶ Power Over Ethernet (POE) <ul style="list-style-type: none"> - See Power Supply section below for a 3rd party POE solution. <p>If required, 15 ft. extension cable (CBL-36-S15EX-01) can be used.</p>
<p>FRU-3600-R1CP (Point-To-Point - includes EA3600-R1CP-00)</p> <p>FRU-3600-R1CM (Multi-Point - includes EA3600-R1CM-00)</p>		<p>36XX Series Network Connect for Manufacturing Adapter - Rockwell (EtherNet/IP), Modbus, TCP/IP</p>	<ul style="list-style-type: none"> ▶ Adapter connects 36xx series scanners to Programmable Logic Controllers (PLC) used in manufacturing environments. ▶ Uses industrial protocol used by the following PLC vendors: <ul style="list-style-type: none"> - EtherNet/IP (Rockwell) - Modbus TCP ▶ Also supports generic TCP/IP connections to non-PLC hosts. ▶ Connects to 36xx scanner via serial connection and will power scanner (including DS3608-ER in default power mode). ▶ Adapter is IP40 rated, -30°C to +50°C operating temp. ▶ NOTE: Point-To-Point model supports connection of one 36XX scanner and provides support for host notification of scanner trigger information. Multi-Point configuration provides support for up to 7 scanners - does not provide host notification of scanner(s) trigger info. ▶ NOTE: This is a Spare/Service Parts item. Order by contacting Zebra Support Center - see SMB 6233 for details. This item is normally packaged in a Network Connect KIT that may include a 36xx series scanner. 	<ul style="list-style-type: none"> ▶ Serial Scanner Cable for DS36xx <ul style="list-style-type: none"> - For STB/FLB 3678 Cradle (cordless scanners) use CBA-RF5-S07ZAR - For 3608 (corded scanners) use CBA-RF2-C09ZAR <p>If required, 15 ft. extension cable (CBL-36-S15EX-01) can be used with either cable listed above.</p> <ul style="list-style-type: none"> ▶ External Power (if Adapter will not be powered from 24V PLC connection) <ul style="list-style-type: none"> - Power Supply (PWR-BGA12V50W0WW) - DC Line Cord (CBL-DC-388A1-01) - AC Line Cord (23844-00-00R or country specific version) ▶ Power Over Ethernet (PoE) <ul style="list-style-type: none"> - See Power Supply section below for a 3rd party PoE solution.

<p>FRU-3600-S1CP (Point-To-Point - includes EA3600-S1CP-00)</p> <p>FRU-3600-S1CM (Multi-Point - includes EA3600-S1CM-00)</p>		<p>36XX Series Network Connect for Manufacturing Adapter - Siemens (Profinet), Modbus, TCP/IP</p>	<ul style="list-style-type: none"> ▶ Adapter connects 36xx series scanners to Programmable Logic Controllers (PLC) used in manufacturing environments. ▶ Uses industrial protocol used by the following PLC vendors: <ul style="list-style-type: none"> - Profinet (Siemens) - Modbus TCP ▶ Also supports generic TCP/IP connections to non-PLC hosts. ▶ Connects to 36xx scanner via serial connection and will power scanner (including DS3608-ER in default power mode). ▶ Adapter is IP40 rated, -30°C to +50°C operating temp. ▶ NOTE: Point-To-Point model supports connection of one 36XX scanner and provides support for host notification of scanner trigger information. Multi-Point configuration provides support for up to 7 scanners - does not provide host notification of scanner(s) trigger info. ▶ NOTE: This is a Spare/Service Parts item. Order by contacting Zebra Support Center - see SMB 6233 for details. This item is normally packaged in a Network Connect KIT that may include a 36xx series scanner. 	<ul style="list-style-type: none"> ▶ Serial Scanner Cable for DS36xx <ul style="list-style-type: none"> - For STB/FLB 3678 Cradle (cordless scanners) use CBA-RF5-S07ZAR - For 3608 (corded scanners) use CBA-RF2-C09ZAR <p>If required, 15 ft. extension cable (CBL-36-S15EX-01) can be used with either cable listed above.</p> <ul style="list-style-type: none"> ▶ External Power (if Adapter will not be powered from 24V PLC connection) <ul style="list-style-type: none"> - Power Supply (PWR-BGA12V50W0WW) - DC Line Cord (CBL-DC-388A1-01) - AC Line Cord (23844-00-00R or country specific version) ▶ Power Over Ethernet (POE) <ul style="list-style-type: none"> - See Power Supply section below for a 3rd party POE solution.
--	---	---	---	---

Misc

Misc				
Part Number	Picture	Description	Notes	Required Items
BRKT-MM0036W-00		Forklift Cradle Mounting Bracket	<ul style="list-style-type: none"> ▶ Used to mount STB3678 or FLB3678 to forklift ▶ Vibration dampening ▶ This is the same bracket used on the FLB3478/FLB3578 cradles 	
11-35035-01R		Holster	Mounts to belt or pants	
<p>9009397</p> <p>▶ Discontinued 2/2019 - see PMB 10057</p>				



STND-AS0036-07		Intellistand	<ul style="list-style-type: none"> ► Twilight Black color 	
RAP-396U		RAM® Power-Grip™ Universal Scanner Gun Holder	<ul style="list-style-type: none"> ► Universal scanner gun holder features replaceable elastomeric fins for a secure fit ► Includes both side and bottom mounting attachment points ► Made of high-strength composites with stainless steel thread post for durability and reliability in the most demanding environments ► Uses 4-Hole AMPS: 1.181" x 1.496" pattern when selecting bracket for mounting to fork lift. 	<ul style="list-style-type: none"> ► Typically mounted on forklifts using RAM C size (1.5") ball mounts. Attach RAM Round Plate Base (RAM-202U) to the holder and then additional RAM C size brackets to complete the installation. Refer to the Common Mounting Accessories TAG for available selections.
MNT-RAM-INDSC		RAM Industrial Scanner Mount Kit 	<ul style="list-style-type: none"> ► Universal scanner gun holder features replaceable elastomeric fins for a secure fit ► Includes both side and bottom mounting attachment points ► Made of high-strength composites with stainless steel thread post for durability and reliability in the most demanding environments ► Includes RAM Power Grip Holder (RAP-396U), RAM Double Socket arm (RAM-201U), RAM Round Plate Base (RAM-202U) 	<ul style="list-style-type: none"> ► Typically mounted on forklifts using RAM C size (1.5") ball mounts. Requires additional RAM C size bracket to attach kit to vehicle. Refer to the Common Mounting Accessories TAG for available selections.
21-52612-01R		Rugged Scanner Holder	<ul style="list-style-type: none"> ► Can be mounted to forklift ► Holder is padded to protect scanner and provide secure grip. ► Uses RAM Medium Length Double Ball Drill-Down Mount with Diamond Plate (RAM-B-138U). 	







<p>3PTY-PCLIP-216239</p> <p>NOTE: Products sold that do not bear the Zebra brand name are serviced and supported exclusively by their manufacturers in accordance with terms and conditions packaged with the products. Zebra's Limited Warranty does not apply to products that are not Zebra branded, even if packaged or sold with Zebra products. Please contact the manufacturer directly for technical support and customer service.</p>		<p>ProClip Universal Scanner Holder</p>	<ul style="list-style-type: none"> ▶ Universal Fit for devices to 3.26 W x 4.88 H x 2.28 D Inches (83x124x58 mm) ▶ Open slot design for trigger handles ▶ AMPS hole pattern for easy mounting ▶ Can be attached to a ProClip pedestal or any flat surface ▶ Made from high quality durable plastic 	
<p>11-66553-06R</p>		<p>Wall Mount Holder</p>		
<p>241464 (shown in picture)</p> <p>241480 (includes vibration dampers)</p> <p>(3rd party) *</p> <p>https://www.proclipusa.com</p>		<p>ProClip Mounting Plate</p>	<ul style="list-style-type: none"> ▶ Mounting plate keeps the scanner within easy reach. ▶ Uses AMPS hole pattern for easy mounting. ▶ Can be attached to a ProClip pedestal or any flat surface. ▶ Version with vibration dampers recommended for use on forklifts. 	
<p>A1235ST (3rd party) *</p> <p>https://shliptrading.com</p>		<p>Shilpi Holster - Wearable or Fixed Mount</p>	<ul style="list-style-type: none"> ▶ Durable Ballistic Nylon Holster. ▶ Skid-proof pad on back to prevent sliding around on waist belt. ▶ Integral belt loop with snap for quick on/off belt ▶ Includes two elastic loop pockets for pens. ▶ Grommeted hole at bottom for easy in/out of unit and drainage. ▶ Stiffeners for structure and rigidity. ▶ Includes two plastic cable tie-wraps for mounting on fork lifts or other fixed mount installations. ▶ Also compatible with 34xx/35xx series scanners. ▶ Can be used with optional Waist Belt for Holster (A1227ST). 	
<p>123-8Z3 (Holder with 8 foot retractor cable)</p> <p>123-12Z3 (Holder with 12 foot retractor cable)</p> <p>(3rd party) *</p> <p>http://www.jlcsolutions.com/</p>		<p>JLC Cablesaver Scanner holder</p>	<ul style="list-style-type: none"> ▶ Includes cable management system ▶ Provides protection from over extending and failures due to broken cable cuts and broken connections 	
<p>520-12-Z3 (12 volt holder)</p> <p>520-24-Z3 (24 volt holder)</p> <p>520-3648-Z3 (36-48 volt holder)</p> <p>(3rd party) *</p> <p>http://www.jlcsolutions.com/</p>		<p>JLC Thermotrax heated scanner holder with cable management</p>	<ul style="list-style-type: none"> ▶ Eliminates "Fogging" and "Freezing" on laser scanner lens due to temperature and humidity changes. ▶ Insures "good reads" in the harsh environments where rapid or extreme temperature changes occur such as traveling from a refrigerated or frozen storage area to a loading dock, from an air-conditioned warehouse to outdoors, or any place where condensation is likely to occur on the scanner lens. ▶ Includes cable management system to ensure longer life of cables and scanners 	











<p>523-12-Z3 (12 volt holder)</p> <p>523-24-Z3 (24 volt holder)</p> <p>523-3648-Z3 (36-48 volt holder)</p> <p>(3rd party) *</p> <p>http://www.jlcsolutions.com/</p>		<p>JLC Heated scanner holder without cable management</p>	<ul style="list-style-type: none"> ▶ Eliminates "Fogging" and "Freezing" on laser scanner lens due to temperature and humidity changes. ▶ Insures "good reads" in the harsh environments where rapid or extreme temperature changes occur such as traveling from a refrigerated or frozen storage area to a loading dock, from an air-conditioned warehouse to outdoors, or any place where condensation is likely to occur on the scanner lens. ▶ 523 Scanner Heater is a newly designed smaller heater that takes up less real-estate on the lift trucks allowing more space to operate. 	
<p>7160-1306 (3rd party) *</p> <p>https://www.gamberjohnson.com</p>		<p>Gamber-Johnson Scanner Pocket Mount with Small Back Plate</p>	<ul style="list-style-type: none"> ▶ Scanner mount is designed to support scanner or handheld computer in a rugged environment by holding it securely to the overhead guard leg of fork lift vehicle. ▶ Adjustable in width, and offers 3 mounting orientations from the overhead guard leg or one of Gamber-Johnson's extension bars. ▶ Designed to hold most handheld computers and scanners. ▶ Adjustable to fit 3.5" to 4.5" width and set at 2.5" tall ▶ Designed to be orientated inside, outside, or inline with the overhead guard leg. ▶ Attaches to rectangular overhead guard legs that are 1.5 in to 2.5 in (3.81 cm to 6.35 cm) wide. 	
<p>(3rd party)</p> <p>http://logisterra.com/products/symbol/symbol.html</p>	<p>Logisterra website</p>	<p>Additional Holsters</p>		
<p>AF2526DW (3rd party) *</p> <p>http://www.ultimacase.com/</p>		<p>Ultima Case Fixed Mount Holster</p>	<ul style="list-style-type: none"> ▶ Open top design allows for quick access. ▶ Mount to a Pole / Forklift / Wall / Handcart ▶ Perfect for when your DS3600 is used in a primary location 	
<p>AE2381DW (3rd party) *</p> <p>http://www.ultimacase.com/</p>		<p>Ultima Case Insulated Boot</p>	<ul style="list-style-type: none"> ▶ Thinsulate padded for minimizing heat loss without extra bulk. ▶ Two snaps at bottom for quick on/off. ▶ D-ring on top for attaching to an optional retractor. 	





AE2385DW (3rd party) *		Ultima Case Protective Boot	<ul style="list-style-type: none"> ▶ Velcro for quick on/off. ▶ D-ring on top for attaching to an optional retractor. 	
http://www.ultimacase.com/				
A1227ST (3rd party) *		Shilpi Belt for Holster	<ul style="list-style-type: none"> ▶ Belt is 2 inches wide ▶ Extends to 48 inches ▶ Quick on/off snap buckle 	
https://www.shilpitrading.com				
50-12500-066		Wrist Strap	<ul style="list-style-type: none"> ▶ Attaches to bottom tether point on handle of 3678 	
50-15400-031		Tool Balancer/Pulley	<ul style="list-style-type: none"> ▶ Attaches to tether point on top of scanner. ▶ Not compatible with 36xx series devices with color display and keypad which do not have a tether point. 	
DS3600-KD-DEV-KIT		Custom Application Development Kit for DS3678-KD	<ul style="list-style-type: none"> ▶ Kit is used to debug custom applications written for the DS3678-KD (keyboard and display) unit. ▶ Kit includes: <ul style="list-style-type: none"> - DS3678-KD with debug ribbon cable - DS3678 cradle (STB3678-C100F3WW) - Cradle cable (CBA-U46-S07ZAR) - Debug board with stand - USB-A to USB-B cable for debug board - ST-LINK/V2 debug dongle 	

Power Supplies/Power Cords

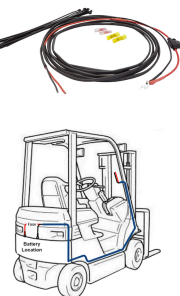

Part Number	Picture	Description	Notes	Required Items
CBL-DC-451A1-01		DC Power Cord	<ul style="list-style-type: none"> ▶ Used along with Power Supply PWR-BGA12V50W0WWW to power 36xx series scanners. ▶ NOT compatible for charging 4-Slot Battery Charger. ▶ Cable length is 1.5 meters 	
CBL-DC-375A1-01		DC Power Cord	<ul style="list-style-type: none"> ▶ Used along with Power Supply PWR-BGA12V50W0WWW to power 4-Slot Battery Charger. ▶ Can also be used as alternate DC Line cord for use with Power Supply PWR-BGA12V50W0WWW to power scanners instead of CBL-DC-451A1-01. Must be used with Filter Adapter Cable (CBL-36-453A-01). ▶ Cable length is 1.5 meters ▶ NOTE: CBL-DC-451A1-01 is the preferred and recommended DC Line Cord to be used with the 36xx series. 	

CBL-DC-388A1-01		DC Power Cord	<ul style="list-style-type: none"> ▶ Used along with Power Supply PWR-BGA12V50W0WW to power EA3600 Network Connect for Manufacturing Adapters. ▶ Cable length is 1.8 meters 	
CBL-36-453A-01		Filter Adapter Cable	<ul style="list-style-type: none"> ▶ Used when using one of the following <ul style="list-style-type: none"> - DC Power Cord CBL-DC-375A1-01 and 7 ft. USB cables requiring an external power supply (CBA-U42-S07PAR and CBA-UF0-S07ZAR) for powering STB or FLB cradles. - PWRS-14000-148R power supply (or similar Level V efficiency power supplies) and 7 ft. USB cables requiring an external power supply (CBA-U42-S07PAR and CBA-UF0-S07ZAR) for powering STB or FLB cradles. ▶ Provides additional regulatory interference shielding/filtering required by these cables. ▶ Cable is not required when using Level VI PWR-BGA12V50W0WW power supply and CBL-DC-451A1-01 DC Line Cord. ▶ Cable length is approximately 5.5 in. 	
PWR-BGA12V50W0WW		Power Supply	<ul style="list-style-type: none"> ▶ 100-240 VAC, 12V, 4.16A, 50W ▶ Provides US DOE Level VI compliance for power efficiency. ▶ When connected to STB3678/FLB3678, will charge a fully depleted battery in about 3 hours. ▶ Replaces PWRS-14000-148R 	<ul style="list-style-type: none"> ▶ DC Line Cord (CBL-DC-451A1-01 or CBL-DC-375A1-01) ▶ AC Line Cord (23844-00-00R or country specific version)
KIT-PWR-12V50W		Power Supply Kit	<ul style="list-style-type: none"> ▶ Includes Power Supply (PWR-BGA12V50W0WW) and DC Line Cord (CBL-DC-388A1-01) ▶ Used to power EA3600 Network Connect for Manufacturing Adapters. 	<ul style="list-style-type: none"> ▶ AC Line Cord (23844-00-00R or country specific version)
23844-00-00R		AC Line Cord	<ul style="list-style-type: none"> ▶ This AC Line Cord is for use in North America. See the AC Line Cords by Country TAG for comparable line cords to use in other countries. 	
PWR-WUA5V6W0WW		USB Power Supply	<ul style="list-style-type: none"> ▶ Can be used along with USB cable to create a "Charge-Only" cradle for customers wanting to pair 3678 scanner directly to host. ▶ Includes four international plugs for use in US, UK, EU, and AU. Additional plugs can be purchased separately for other countries. ▶ 5.2V, 1.2A, 6W output ▶ Provides US DOE Level VI compliance for power efficiency 	<ul style="list-style-type: none"> Charging-Communication Cradle (STB3678-C100F3WW or FLB3678-C100F3WW) AND USB Cable (CBA-U46-S07ZAR)
PWR-WUA5V6W0WHT		USB Power Supply, White color	<ul style="list-style-type: none"> ▶ Can be used along with USB cable to create a "Charge-Only" cradle for customers wanting to pair 3678 scanner directly to host. ▶ Includes four international plugs for use in US, UK, EU, and AU. Additional plugs can be purchased separately for other countries. ▶ 5.2V, 1.2A, 6W output ▶ Provides US DOE Level VI compliance for power efficiency ▶ NOTE: SKU is restricted sale. May require Zebra Product Management approval to order. 	<ul style="list-style-type: none"> Charging-Communication Cradle (STB3678-C100F3WW or FLB3678-C100F3WW) AND USB Cable (CBA-U46-S07ZAR)
CN-000803-01		Spare/Replacement USB Power Supply AC Clip for Australia (AUS)	<ul style="list-style-type: none"> ▶ This AC Clip is normally included with PWR-WUA5V6W0WW ▶ 2 pin Australia plug 	<ul style="list-style-type: none"> USB Power Supply (PWR-WUA5V6W0WW)

CN-000803-02		USB Power Supply AC Clip for Argentina (ARG)		USB Power Supply (PWR-WUA5V6W0WW)
CN-000803-03		USB Power Supply AC Clip for Korea (KOR)		USB Power Supply (PWR-WUA5V6W0WW)
CN-000803-04		<u>Spare/Replacement</u> USB Power Supply AC Clip for US (US)	<ul style="list-style-type: none"> ▶ This AC Clip is normally included with PWR-WUA5V6W0WW ▶ 2 pin US plug 	USB Power Supply (PWR-WUA5V6W0WW)
CN-000803-05		<u>Spare/Replacement</u> USB Power Supply AC Clip for Europe (EU)	<ul style="list-style-type: none"> ▶ This AC Clip is normally included with PWR-WUA5V6W0WW 	USB Power Supply (PWR-WUA5V6W0WW)
CN-000803-06		<u>Spare/Replacement</u> USB Power Supply AC Clip for UK (UK)	<ul style="list-style-type: none"> ▶ This AC Clip is normally included with PWR-WUA5V6W0WW 	USB Power Supply (PWR-WUA5V6W0WW)
CN-000803-07		USB Power Supply AC Clip for China (CHN)	<ul style="list-style-type: none"> ▶ straight pins China plug 	USB Power Supply (PWR-WUA5V6W0WW)
CN-000803-08		USB Power Supply AC Clip for Brazil (BRA)	<ul style="list-style-type: none"> ▶ 2 pin Brazil plug 	USB Power Supply (PWR-WUA5V6W0WW)
CN-000803-09		USB Power Supply AC Clip for India (IND)		USB Power Supply (PWR-WUA5V6W0WW)
PWRS-14000-251R		Fork Lift Cradle High Voltage Power Converter	<ul style="list-style-type: none"> ▶ Replaces 50-14000-251R, meets regulatory requirements for use in EU countries. ▶ Supports 36, 48, 60 nominal VDC for lift vehicles. ▶ 18-75VDC input, 12VDC output ▶ When connected to STB3678/FLB3678, will charge a fully depleted battery in about 4 hours. ▶ Energy Star Compliant 	<ul style="list-style-type: none"> ▶ Fork Lift DC Power Cable (CBL-36-452A-01) ▶ Also requires a scanner cable listed as "Powered" which includes pigtail cable for barrel jack power cable (example is CBA-U42-S07PAR)
PWRS-14000-252R		Fork Lift Cradle Low Voltage Power Converter	<ul style="list-style-type: none"> ▶ Replaces 50-14000-252R, meets regulatory requirements for use in EU countries. ▶ Supports 12, 24 nominal VDC for lift vehicles. ▶ 9-30VDC input, 12VDC output ▶ When connected to STB3678/FLB3678, will charge a fully depleted battery in about 4 hours. ▶ Energy Star Compliant 	<ul style="list-style-type: none"> ▶ Fork Lift DC Power Cable (CBL-36-452A-01) ▶ Also requires a scanner cable listed as "Powered" which includes pigtail cable for barrel jack power cable (example is CBA-U42-S07PAR)
CBL-36-452A-01		Forklift DC Power Cable	<ul style="list-style-type: none"> ▶ Connects Forklift Power Supply (PWRS-14000-251R/PWRS-14000-252R) to 3678 Cradles or cables requiring external power supply. ▶ NOTE: 3678 series Cradles do not include barrel jack connector for this power cable. Requires a scanner cable labeled as "Powered" to be used. These cables include additional pigtail cable for connecting barrel jack power cable. ▶ Cable length is approximately 6.5 ft. 	<ul style="list-style-type: none"> ▶ Fork Lift Cradle Power Converter (PWRS-14000-251R or PWRS-14000-252R) ▶ Also requires a scanner cable listed as "Powered" which includes pigtail cable for barrel jack power cable (example is CBA-U42-S07PAR)

<p>3PTY-GJ-7300-0467</p> <p>NOTE: Products sold that do not bear the Zebra brand name are serviced and supported exclusively by their manufacturers in accordance with terms and conditions packaged with the products. Zebra's Limited Warranty does not apply to products that are not Zebra branded, even if packaged or sold with Zebra products. Please contact the manufacturer directly for technical support and customer service. See PMB 11136 for more info.</p>		<p>Forklift Cradle Power Supply, 20-60 VDC</p>	<ul style="list-style-type: none"> ▶ Alternative power supply to PWRS-14000-251R or PWRS-14000-252R, although Zebra has not validated this solution and does not endorse it. ▶ This power supply is typically used with the Gamber-Johnson forklift cradle for EMC devices, but provides the same power supply requirements for the 36XX. ▶ 20-60 VDC input, 12V DC output to cradles. ▶ Optional Forklift Power Supply Clamp (3PTY-GJ-7160-1333) can be used to mount power supply to vehicle. Refer to Common Mounting Accessories TAG for details. 	
<p>7300-0466 (12-32V forklift vehicles)</p> <p>7300-0467 (20-60V forklift vehicles)</p> <p>(3rd party) *</p> <p>http://www.gamberjohnson.com/</p>		<p>Forklift Cradle Power Supply</p>	<ul style="list-style-type: none"> ▶ Alternative power supply to PWRS-14000-251R or PWRS-14000-252R, although Zebra has not validated this solution and does not endorse it. ▶ This power supply is typically used with the Gamber-Johnson forklift cradle for EMC devices, but provides the same power supply requirements for the 36XX. 	
<p>3PTY-GJ-7300-0482</p> <p>NOTE: Products sold that do not bear the Zebra brand name are serviced and supported exclusively by their manufacturers in accordance with terms and conditions packaged with the products. Zebra's Limited Warranty does not apply to products that are not Zebra branded, even if packaged or sold with Zebra products. Please contact the manufacturer directly for technical support and customer service. See PMB 11136 for more info.</p>		<p>Forklift Wiring Kit</p>	<ul style="list-style-type: none"> ▶ Designed to make the install more professional by providing the correct gauge of wire and finishing accessories to complete the install on a forklift. ▶ Includes: <ul style="list-style-type: none"> - 15 feet of 12 gauge (AWG) wire (red and black) for handling longer wire runs and varied power applications. - In-line 15 amp fuse protects device from over voltage - Quick connects for attaching 12 gauge wire to 18 gauge power supply wires - (10) 12-inch zip ties for ease of installation ▶ If using this wiring harness for application outside of material handling, a 12 gauge wire at 15 ft long can handle a 30A fuse and customer will need to change the fuse on their own. 	
<p>TL-POE10R (POE Splitter)</p> <p>(3rd party) *</p> <p>http://www.tp-link.com/</p>		<p>PoE Power Supply solution for EA3600</p>	<ul style="list-style-type: none"> ▶ Used to power EA3600 Network Connect for Manufacturing adapter via Power over Ethernet (PoE). ▶ Requires two components: <ol style="list-style-type: none"> 1. Midspan/Power Injector that will provide power on Ethernet switch end. Exact model of Midspan is customer/installation specific. 2. PoE Splitter that will separate data from power on EA3600 end and connect to barrel jack power connector and Ethernet port on EA3600. 	<p>Will require DC Line cord (barrel jack connector) to connect PoE Splitter to EA3600</p>

Batteries				
Part Number	Picture	Description	Notes	Required Items

<p>BTRY-36IAB0E-00</p> <p>BTRY-36IAB0E-00K (India & South Korea only)</p>		<p>3678 Series Spare Battery with PowerPrecision Plus (3150 mAh)</p> 	<ul style="list-style-type: none"> ▶ Designed, manufactured & tested to meet rigorous controls & standards ▶ Premium-grade cells with higher capacity & longer life cycle ▶ Designed to help prevent overcharging & electrical shock ▶ Information available: <ul style="list-style-type: none"> - Battery Asset Information <ul style="list-style-type: none"> + Manufacture Date of Battery + Serial Number of Battery + Model Number of Battery + Firmware Version of Battery + Design Capacity - Battery Life Statistics <ul style="list-style-type: none"> + State of Health Meter + Charge Cycles Consumed - Battery Status (at Time of Poll) <ul style="list-style-type: none"> + State of Charge + Remaining Capacity + Charge Status + Remaining Time to Complete Charging + Battery Voltage / Current - Battery Temperature <ul style="list-style-type: none"> + Present/Highest/Lowest 	
---	---	--	---	--